

3500/42M Proximator*/Seismic Monitor

Product Datasheet

Bently Nevada* Asset Condition Monitoring



Description

The 3500/42M Proximator*/Seismic Monitor is a 4-channel monitor that accepts input from proximity and seismic transducers, conditions the signal to provide various vibrations and position measurements, and compares the conditioned signals with user-programmable alarms.

You can program each channel using the 3500 Rack Configuration Software to perform the following functions:

- Radial vibration
- Thrust position
- Differential expansion
- Eccentricity
- REBAM*
- Acceleration
- Velocity
- Shaft absolute
- Circular acceptance region



The monitor channels are programmed in pairs and can perform up to two of the aforementioned functions at a time. For example, Channels 1 and 2 can perform one function while channels 3 and 4 perform another or the same function.

The primary purpose of the 3500/42M Proximator*/Seismic Monitor is to provide the following:

- Machinery protection by continuously comparing monitored parameters against configured alarm setpoints to drive alarms
- Essential machine information for both operations and maintenance personnel

Each channel, depending on configuration, typically conditions its input signal to generate various parameters called **static values**. You can configure **alert setpoints** for each active static value and **danger setpoints** for any two of the active static values.



Specifications

Inputs

Signal	Accepts from 1 to 4 proximity, velocity or acceleration transducer signals
Power consumption	7.7 watts, typical
Input Impedance	
Standard I/O	10 k Ω (Proximator and acceleration inputs)
TMR I/O	The effective impedance of three Bussed TMR I/O channels wired in parallel to one transducer is 50 k Ω .

Sensitivity

Radial Vibration	3.94 mV/ μ m (100 mV/mil) or 7.87 mV/ μ m (200 mV/mil)
Thrust	3.94 mV/ μ m (100 mV/mil) or 7.87 mV/ μ m (200 mV/mil)
Eccentricity	3.94 mV/ μ m (100 mV/mil) or 7.87 mV/ μ m (200 mV/mil)
Differential Expansion	0.394 mV/ μ m (10 mV/mil) or 0.787 mV/ μ m (20 mV/mil)
REBAM	40 mV/ μ m (1000 mV/mil) or 80 mV/ μ m (2000 mV/mil)
Acceleration & Acceleration ²	10 mV/ (m/s ²) (100 mV/g)
Velocity & Velocity ²	20 mV/ (mm/s) pk (500 mV/ (in/s) pk) or 5.8 mV/ (mm/s) pk (145 mV/ (in/s) pk) or 4 mV/ (mm/s) pk (100 mV/ (in/s) pk)
Shaft Absolute, Radial Vibration	3.94 mV/ μ m (100 mV/mil) or 7.87 mV/ μ m (200 mV/mil)
Shaft absolute, Direct	3.94 mV/ μ m (100 mV/mil) or 7.87 mV/ μ m (200 mV/mil)
Shaft absolute, Velocity	20 mV/ (mm/s) pk (500 mV/ (in/s) pk) or 5.8 mV/ (mm/s) pk (145 mV/ (in/s) pk) or 4 mV/ (mm/s) pk (100 mV/ (in/s) pk)
Circular Acceptance Region	See Radial Vibration on page 3.

Outputs

Front Panel LEDs	
OK LED	Indicates when the 3500/42M Proximator*/Seismic Monitor is operating properly.
TX/RX LED	Indicates when the 3500/42M Proximator*/Seismic Monitor is communicating with other modules in the 3500 rack.
Bypass LED	Indicates when the 3500/42M Proximator*/Seismic Monitor is in Bypass Mode.
Buffered Transducer Outputs	The front of each monitor has one coaxial connector for each channel. Each connector is short-circuit protected.
Output Impedance	550 Ω
Transducer Power Supply	-24 Vdc
Recorder	+4 to +20 mA Values are proportional to monitor full-scale. The monitor provides individual recorder values for each channel. Monitor operation is unaffected by short circuits on recorder outputs.
Voltage Compliance (current output)	0 to +12 Vdc range across load Load resistance is 0 to 600 Ω .
Resolution	0.3662 μ A per bit \pm 0.25% error at room temperature \pm 0.7% error over temperature range Update rate approximately 100 ms or less
Shaft Absolute Buffered Outputs	The Shaft Absolute I/O modules have one output for each channel group. Each output is short-circuit protected.
Shaft Absolute Output Impedance	300 Ω
Output supply parameters	See Output Supply Parameters on page 9.

Signal Conditioning

Specified at +25 °C (+77 °F) unless otherwise noted.

Radial Vibration

Frequency Response	
Direct filter	User-programmable Single-pole -3db at 4 Hz to 4000 Hz or 1 Hz to 600 Hz ± 1% accuracy
Gap filter	-3 dB at 0.09 Hz
Not 1X filter	60 cpm to 15.8 times running speed Constant Q notch filter Minimum rejection in stopband of -34.9 dB
Smax	0.125 to 15.8 times running speed
1X and 2X vector filter	Constant Q Filter Minimum rejection in stopband of -57.7 dB



1X and 2X Vector, Not 1X, and Smax parameters are valid for machine speeds of 60 cpm to 60,000 cpm.

Accuracy	
Direct and Gap	Exclusive of filtering Within ±0.33% of full-scale typical ±1% maximum
1X and 2X	Within ±0.33% of full-scale typical ±1% maximum
Smax	Within ±5% maximum
Not 1X	±3% for machine speeds less than 30,000 cpm ±8.5% for machine speeds greater than 30,000 cpm

Thrust and Differential Expansion

Accuracy	Within ±0.33% of full-scale typical ±1% maximum
Frequency Response	
Direct filter	-3 dB at 1.2 Hz
Gap filter	-3 dB at 0.41 Hz

Eccentricity

Accuracy	Within ±0.33% of full-scale typical ±1% maximum
Frequency Response	
Direct filter	-3 dB at 15.6 Hz
Gap filter	-3 dB at 0.41 Hz

Acceleration

Accuracy	Within ±0.33% of full-scale typical ±1% maximum Exclusive of filters
Filter Quality	
High-pass	4-pole (80 dB per decade, 24 dB per octave)
Low-pass	4-pole (80 dB per decade, 24 dB per octave)

The following table shows the frequency ranges if both channels of a channel pair are enabled:

Frequency Response			
Output Type	Without Filter	Low or High Pass Filter	With Integration
RMS	10 to 30,000 Hz	10 to 9,155 Hz	10 to 9,155 Hz
Peak	3 to 30,000 Hz	3 to 9,155 Hz	10 to 9,155 Hz

The following table shows the frequency ranges if a single channel of a channel pair is enabled:

Frequency Response		
Output Type	Without Filter Low or High Pass Filter	With Integration
RMS	10 to 30,000 Hz	10 to 14,500 Hz
Peak	3 to 30,000 Hz	10 to 14,500 Hz

Acceleration II

Accuracy	Within $\pm 0.33\%$ of full scale typical $\pm 1\%$ maximum Exclusive of filters
Filter Quality	
High-pass	4-pole (80 dB per decade, 24 dB per octave)
Low-pass	4-pole (80 dB per decade, 24 dB per octave)
Frequency Response	
Bias filter	-3 dB at 0.01 Hz
Not OK filter	-3 dB at 2400 Hz
1X and 2X vector filter	Valid for machine speeds of 60 cpm to 100,000 cpm

The following table represents the frequency ranges for the 3500/42M Proximator*/Seismic Monitor under different options using the Acceleration II Channel Type:

Output Type	Without Filter Low or High Pass Filter	With Integration
RMS	10 to 30,000 Hz	10 to 20,000 Hz
Peak	3 to 30,000 Hz	10 to 20,000 Hz

Velocity and Velocity II

Accuracy	Within $\pm 0.33\%$ of full-scale typical $\pm 1\%$ maximum Exclusive of filters
Velomitor* sensor accuracy	Full Scale 0-0.5: $\pm 3\%$ typical Full Scale 0-1.0: $\pm 2\%$ typical Full Scale 0-2.0: $\pm 1\%$ typical
Velomitor sensor accuracy with barriers	Under radiated immunity conditions, add $\pm 11\%$ for all full scale ranges. The total Velomitor sensor accuracy will be $\pm 15\%$.
Frequency Response	
Bias	-3dB at 0.01 Hz Velocity II only
Not OK filter	-3 dB at 40 Hz Velocity II only
RMS	10 to 5,500 Hz, -3 dB
Peak or peak-to-peak	3 to 5,500 Hz, -3 dB
1X and 2X vector filter	Valid for machine speeds of 60 to 100,000 cpm Velocity II only
Filter Quality	
High-pass	4-pole (80 dB per decade, 24 dB per octave)
Low-pass	2-pole (40 dB per decade, 12 dB per octave)

Shaft Absolute, Radial Vibration

Frequency Response	
Direct filter	User-programmable 4 Hz to 4000 Hz or 1 Hz to 600 Hz
Gap filter	-3 dB at 0.09 Hz
1X vector filter	Valid for machine speeds of 240 cpm to 60,000 cpm
Accuracy	
Direct and gap	Within $\pm 0.33\%$ of full-scale typical $\pm 1\%$ maximum
1X	Within $\pm 0.33\%$ of full-scale typical $\pm 1\%$ maximum

Shaft Absolute, Velocity

Accuracy	Within $\pm 0.33\%$ of full scale typical $\pm 1\%$ maximum Exclusive of filters
Frequency Response	
Peak or peak-to-peak	User-programmable 1 to 4,000 Hz, -3 dB
Filter Quality	
High-pass	2-pole (40 dB per decade, 12 dB per octave)
Low-pass	2-pole (40 dB per decade, 12 dB per octave)
1X vector filter	Constant Q Filter Minimum rejection in stopband of -57.7 dB

Shaft Absolute Buffered Output

Accuracy	$\pm 6.0\%$ @ 25 C
Circular acceptance region	See Radial Vibration on page 3.

REBAM

Frequency Response	
Spike	User-programmable from 0.152 to 8678 Hz
Element	User-programmable for BPFO ranging from 0.139 to 3836 Hz High-pass corner is 0.8x BPFO. Low-pass corner is 2.2x BPFO.
Rotor	User programmable from 0.108 to 2221 Hz
Direct	Programmable from 3.906 to 14.2 Hz Selection is determined by Spike and Rotor filters.
Gap	Programmable from 0.002 to 1.0 Hz Selection is determined by the Rotor filter.
1X vector filter	The range of shaft speeds for which the value is valid depends on the nominal shaft speed for which the channel is configured.

The following table summarizes the relationship between nominal shaft speed and the valid speed range:

Nominal Shaft Speed (Hz)	Valid Speed Range (Hz)
10 to <126	0.071 to 160
126 to <252	0.133 to 330
252 to <504	0.25 to 660
504 to 584	0.50 to 750



If a multi-event gear or speed wheel generates the speed input, the upper limitation of the resultant input signal is approximately 20 KHz.

Filter Quality	
Spike high-pass	6-pole Elliptic (155 dB per decade, minimum) Corner frequency is -0.1 dB.
Element bandpass	8-pole Butterworth (155 dB per decade minimum) Corner frequency is -3 dB.
Rotor low-pass	6-pole Elliptic (155 dB per decade, minimum) Corner frequency is -0.1 dB.
Rotor, direct high-pass	1-pole Butterworth (18 dB per decade, minimum) Corner frequency is -3 dB.
Spike, direct low-pass	Corner is -0.3 dB maximum.
Gap low-pass	1-pole Butterworth (18 dB per decade, minimum) Corner frequency is -3 dB.
1X amplitude	Constant Q of 16.67 Stopband frequencies are 0.91 and 1.09 times the running speed. Stopband attenuation is -51 dB minimum.

Accuracy	
Amplitude	Within $\pm 0.33\%$ of full scale typical $\pm 1\%$ maximum when input signal is at the center frequency of the proportional value's passband
Phase	3 degrees error, maximum
Channels enabled	You can use certain configurations to enable only one channel of a channel pair. See REBAM Channels on page 16.

Filter Tracking / Stepping (Requires a valid speed signal)	
Initial condition	Nominal filter set used
Switch from nominal to lower filter set	Current shaft speed $\leq 0.9 \times$ (nominal shaft speed)
Switch from lower to nominal filter set	Current shaft speed $\geq 0.95 \times$ (nominal shaft speed)
Switch from nominal to higher filter set	Current shaft speed $\geq 1.1 \times$ (nominal shaft speed)
Switch from higher to nominal filter set	Current shaft speed $\leq 1.05 \times$ (Nominal Shaft Speed)
Shaft speed error condition	Nominal filter set used

Physical

Monitor Module (Main Board)	
Dimensions (Height x Width x Depth)	241.3 mm x 24.4 mm x 241.8 mm (9.50 in x 0.96 in x 9.52 in)
Weight	0.91 kg (2.0 lb)
I/O Modules (non-barrier)	
Dimensions (Height x Width x Depth)	241.3 mm x 24.4 mm x 99.1 mm (9.50 in x 0.96 in x 3.90 in)
Weight	0.20 kg (0.44 lb)
I/O Modules (barrier)	
Dimensions (Height x Width x Depth)	241.3 mm x 24.4 mm x 163.1 mm (9.50 in x 0.96 in x 6.42 in)
Weight	0.46 kg (1.01 lb)

Rack Space Requirements

Monitor Module	1 full-height front slot
I/O Modules	1 full-height rear slot

Barrier Parameters

The following parameters apply to CSA-NRTL/C and ATEX approvals.

Proximito Barrier	
Circuit Parameters	Vmax (PWR) = 26.80 V (SIG) = 14.05 V Imax (PWR) = 112.8 mA (SIG) = 2.82 mA Rmin (PWR) = 237.6 Ω (SIG) = 4985 Ω
Channel Parameters (entity)	Vmax = 28.0 V Imax = 115.62 mA Rmin (PWR) = 237.6 Ω (SIG) = 4985 Ω
Seismic Barrier	
Circuit Parameters	Vmax (PWR) = 27.25 V Imax (PWR) = 91.8 mA Rmin (PWR) = 297 Ω
Channel Parameters (entity)	Vmax = 27.25 V Imax = 91.8 mA Rmin (PWR) = 297 Ω

Alarms

Alarm Setpoints	Use Rack Configuration Software to set alert levels for each value measured by the monitor and danger setpoints for any two of the values measured by the monitor. Alarms are adjustable from 0 to 100% of full-scale for each measured value. However, when the full-scale range exceeds the range of the transducer, the range of the transducer will limit the setpoint.
Accuracy of alarms	Within 0.13% of the desired value

Alarm Time Delays

You can program alarm delays using **Rack Configuration Software**.

For all channel pair types excluding Shaft Absolute Velocity and REBAM	
Alert	From one to 60 seconds in one second intervals
Danger	0.1 seconds or from one to 60 seconds in 0.5 second intervals
Shaft Absolute Velocity	
Alert	From one to 60 seconds in one second intervals
Danger	0.1 seconds or from one to 60 seconds in 0.5 second intervals
REBAM	
Alert	From the calculated minimum value to 400 seconds in one second intervals
Danger	From the calculated minimum value to 400 seconds in 0.5 second intervals

Static Values



Static values are measurements used to monitor the machine. The 3500/42M Proximator*/Seismic Monitor returns the following static values:

Radial Vibration	Direct, Gap, 1X Amplitude, 1X Phase Lag, 2X Amplitude, 2X Phase Lag, Not 1X Amplitude and Smax Amplitude
Thrust Position	Direct, Gap
Differential Expansion	Direct, Gap
Eccentricity	Peak-to-peak, Gap, Direct Minimum, Direct Maximum
REBAM	Spike, Element, Rotor, Direct, Gap, 1X Amplitude, 1X Phase Lag
Acceleration	Direct Defined as one of the following: RMS Acceleration, Peak Acceleration, RMS Velocity, Peak Velocity, Band-pass peak Acceleration, or Band-pass peak Velocity

Acceleration II	Direct, 1X Amplitude and 2X Amplitude Defined as one of the following: RMS Acceleration, Peak Acceleration, RMS Velocity, Peak Velocity, Band-pass peak Acceleration, or Band-pass peak Velocity Additionally, 1X Phase, 2X Phase and Bias Voltage
Velocity	Direct Defined as one of the following: RMS Velocity, Peak Velocity, peak-to-peak Displacement, Band-pass peak Velocity, Band-pass, or Peak-to-peak Displacement
Velocity II	Direct, 1X Amplitude and 2X Amplitude Defined as one of the following: RMS Velocity, Peak Velocity, peak-to-peak Displacement, Band-pass peak Velocity, Band-pass, or Peak-to-peak Displacement Additionally, 1X Phase, 2X Phase and Bias Voltage
Shaft Absolute, Radial Vibration and Shaft Absolute, Velocity	Direct, Gap, 1X Amplitude, 1X Phase Lag
Circular Acceptance Region	Direct, Gap, 1X Amplitude, 1X Phase Lag, 1X Circular Acceptance Radius, 2X Amplitude, 2X Phase Lag, 2X Circular Acceptance Radius

Hazardous Area Approvals

For the detailed listing of country and product specific approvals, refer to the **Approvals Quick Reference Guide**, document 108M1756, at www.GEmeasurement.com.

CSA/NRTL/C (Approval Option 01)	
When used with I/O module ordering options and internal barriers	<p>Ex nC [ia] IIC T4 Gc Class I, Division 1, Groups A, B, C, D</p> <p>Class I, Zone 2 AEx nC [ia] IIC T4 Gc Class I, Division 1 Groups A, B, C, D</p> <p>T4 @ Ta = -20 °C to +65 °C (-4 °F to +150 °F) per drawing 138547</p>
When used with I/O module ordering options without internal barriers	<p>Ex nC [L] IIC T4 Gc Class I, Division 2, Groups A, B, C, D</p> <p>Class I, Zone 2 AEx nC IIC T4 Gc Class I, Division 2 Groups A, B, C, D</p> <p>T4 @ Ta = -20 °C to +65 °C (-4 °F to +150 °F) per drawing 149243</p>
ATEX/IECEX (Approval Option 02)	
For ATEX/IECEX agency approval ordering options with internal barriers	<p></p> <p>II 3 (1) G Ex nA nC ic [ia Ga] IIC T4 Gc</p> <p>T4 @ Ta = -20 °C to +65 °C (-4 °F to +150 °F)</p>
For ATEX/IECEX agency approval ordering options without internal barriers	<p></p> <p>II 3 G Ex nA nC ic IIC T4 Gc</p> <p>T4 @ Ta = -20 °C to +65 °C (-4 °F to +150 °F)</p>

Environmental Limits

Operating Temperature	
Operating Temperature	When used with Internal/External Termination I/O Module: -30°C to +65°C (-22°F to +150°F)
	When used with Internal Barrier I/O Module (Internal Termination) 0°C to +65°C (32°F to +150°F)
Storage Temperature	-40°C to +85°C (-40°F to +185°F)
Humidity	95% Non-condensing

Compliance and Certifications

EMC	<p>Standards: EN 61000-6-2 Immunity for Industrial Environments EN 61000-6-4 Emissions for Industrial Environments EN 55011/CISPR 11 ISM Equipment</p> <p>European Community Directives: EMC Directive 2014/30/EU</p>
Electrical Safety	<p>Standards: EN 61010-1</p> <p>European Community Directives: LV Directive 2014/35/EU</p>

Output Supply Parameters

The following values are accurate regardless of external barrier connections.

I/O Part and Order Options	Description	Configuration	Supply Parameters		
			U (V)	I (mA)	P (W)
128229-01 A 01	Prox/Seismic I/O Module with Internal Terminations	Prox/Accel	23.9	45.5	1.09
		Velomitor	23.9	45.5	1.09
		Seismoprobe	6.82	2.75	0.02
128240-01 A 02	Prox/Seismic I/O Module with External Terminations	Prox/Accel	23.9	45.5	1.09
		Velomitor	23.9	45.5	1.09
		Seismoprobe	6.82	2.75	0.02
126632-01 A 03	TMR I/O Module with External Terminations	Prox/Accel	23.9	45.5	1.09
		Velomitor	23.9	45.5	1.09
138708-01 A 07	Shaft Absolute I/O Module with Internal Terminations	Prox & Velomitor	23.9	45.5	1.09
		Prox & Seismoprobe	6.82	45.5	0.31
138700-01 A 08	Shaft Absolute I/O Modules with External Terminations	Prox & Velomitor	23.9	45.5	1.09
		Prox & Seismoprobe	6.82	45.5	0.31
140471-01 A 09	Prox/Velom I/O Module with Internal Terminations	Prox/Accel	23.9	45.5	1.09
		Velomitor	23.9	45.5	1.09
140482-01 A 10	Prox/Velom I/O Module with External Terminations	Prox/Accel	23.9	45.5	1.09
		Velomitor	23.9	45.5	1.09

Ordering Information

For the detailed listing of country and product specific approvals, refer to the **Approvals Quick Reference Guide**, document 108M1756, at www.GEmeasurement.com.

Proximitor Seismic Monitor 3500/42 - AXX - BXX

A: I/O Module Type

See **I/O Module Types** on page 12.

B: Agency Approval

00 None

01 CSA / NRTL / C (Class 1, Division 2)

02 ATEX / IECEx / CSA (Class 1, Zone 2)

Option B02 is available only with A04, A05, A06 and A09.

External Termination Blocks

125808-02	Proximitor ET Block Euro Style Connectors
128015-02	Proximitor ET Block Terminal Strip Connectors
132242-01	Prox / Seismic Bussed TMR ET Block Euro Style connectors
132234-01	Prox Seismic Bussed TMR ET Block Terminal Strip connectors
128702-01	Recorder External Termination Block Euro Style connectors
128710-01	Recorder External Termination Block Terminal Strip connectors
140993-01	Shaft Absolute External Termination Block Euro Style connectors
141001-01	Shaft Absolute External Termination Block Terminal Strip
125808-08	Proximitor / Velomitor External Termination Block Euro Style connectors

Cables

3500 Transducert (XDCR Signal to External Termination (ET) Block Cable 129525 - AXXXX - BXX

A: I/O Cable length

0005 5 feet (1.5 metres)

0007 7 feet (2.1 metres)

0010 10 feet (3.0 metres)

0025 25 feet (7.6 metres)

0050 50 feet (15.2 metres)

0100 100 feet (30.5 metres)

B: Assembly instructions

01 Not assembled

02 Assembled

3500 Recorder Output to External Termination (ET) Block Cable 129529 - AXXXX - BXX

A: I/O Cable length

0005 5 feet (1.5 metres)

0007 7 feet (2.1 metres)

0010 10 feet (3.0 metres)

0025 25 feet (7.6 metres)

0050 50 feet (15.2 metres)

0100 100 feet (30.5 metres)

B: Assembly instructions

01 Not assembled

02 Assembled

Spares

176449-02	3500/42M Proximito*/Seismic Monitor
128229-01	Prox/Seismic I/O Module with internal terminations
128240-01	Prox/Seismic I/O Module with external terminations
126632-01	TMR I/O Module with external terminations
00530843	3500/42M Prox/Seismic I/O Module four-pin connector shunt
143489-01	3500/42M Monitor Manual
135489-01	I/O Module with Internal Barriers (internal terminations, 4 x Prox/Accel)
135489-02	I/O Module with Internal Barriers (internal terminations, 2 x Prox/Accel and 2 x Velomitor)
135489-03	I/O Module with Internal Barriers (internal terminations, 4 x Velomitor)
138708-01	Shaft Absolute I/O Module with internal terminations
138700-01	Shaft Absolute I/O Modules with external terminations
00517018	3500/42M Shaft Absolute I/O Module 8-pin connector shunt
140471-01	Prox/Velom I/O Module with internal terminations
140482-01	Prox/Velom I/O Module with External Terminations
00561941	3500/42M Prox/Velom I/O Module 10-pin connector shunt
00580434	Internal I/O Module connector header, Euro style, 8-pin Used on I/O modules 128229-01 and 138708-01
00580432	Internal I/O Module connector header, Euro style, 10-pin Used on I/O modules 128229-01 and 138708-01
00502133	Internal I/O Module connector header, Euro style, 12-pin

Firmware & Software Requirements

	3500/01 software, version 2.50 or later
3500/42M Proximito*/Seismic Monitor	3500/02 software, version 2.20 or later 3500/03 software, version 1.21 or later
Internal Barrier I/O Modules	See the 3500 Internal Barrier datasheet (part number 141495-01)
Shaft Absolute	3500/42M Module Firmware, revision B 3500/01 Software, version 2.61 DM2000 Software, version 3.10 The 3500 Proximito / Seismic Monitor, version M
REBAM	3500/40M Module Firmware – Revision 2.1 3500/01 Software, version 3.30 3500/02 Software, version 2.40 3500/03 Software, version 1.40 DM2000 Software, version 3.40 The 3500 Proximito Monitor, version M
Acceleration II, Velocity II, Circular Acceptance Region	3500/42M Module Firmware, revision 2.10 3500/01 Software, version 3.20 DM2000 Software, version 3.30 The 3500 Proximito Monitor, version M

I/O Module Types

AXX Ordering Option	I/O Part Number	I/O Description	Transducer Type
01	128229-01	Prox/Seismic I/O Module with internal terminations	Seismoprobe Prox/Accel and Velomitor are supported but are not recommended.
02	128240-01	Prox/Seismic I/O Module with external terminations	Seismoprobe Prox/Accel and Velomitor are supported but are not recommended.
03	126632-01	TMR I/O Module with external terminations	Prox/Accel or Velomitor
04	135489-01	I/O Module with internal Barriers, internal terminations, 4 x Prox/Accel	Prox/Accel on channels 1 through 4
05	135489-02	I/O Module with internal barriers, internal terminations, 2 x Prox/Accel and 2 x Velomitor	Prox/Accel on channels 1 and 2 Velomitor on channels 3 and 4
06	135489-03	I/O Module with internal barriers, internal terminations, 4 x Velomitor	Velomitor on channels 1 through 4
07	138708-01	Shaft Absolute I/O Module with internal terminations	Prox/Accel or Velomitor or Seismorprobe
08	138700-01	Shaft Absolute I/O Modules with external terminations	Prox/Accel or Velomitor or Seismorprobe
09	140471-01	Prox/Velom I/O Module with internal terminations	Prox/Accel, Velomitor or HTVS
10	140482-01	Prox/Velom I/O Module with external terminations	Prox/Accel, Velomitor or HTVS



External termination blocks cannot be used with Internal Termination I/O Modules. When ordering I/O modules with external terminations, order the external termination blocks and cable separately for each I/O module.



Use Bussed External Termination Blocks with TMR I/O Modules only.

Graphs and Figures

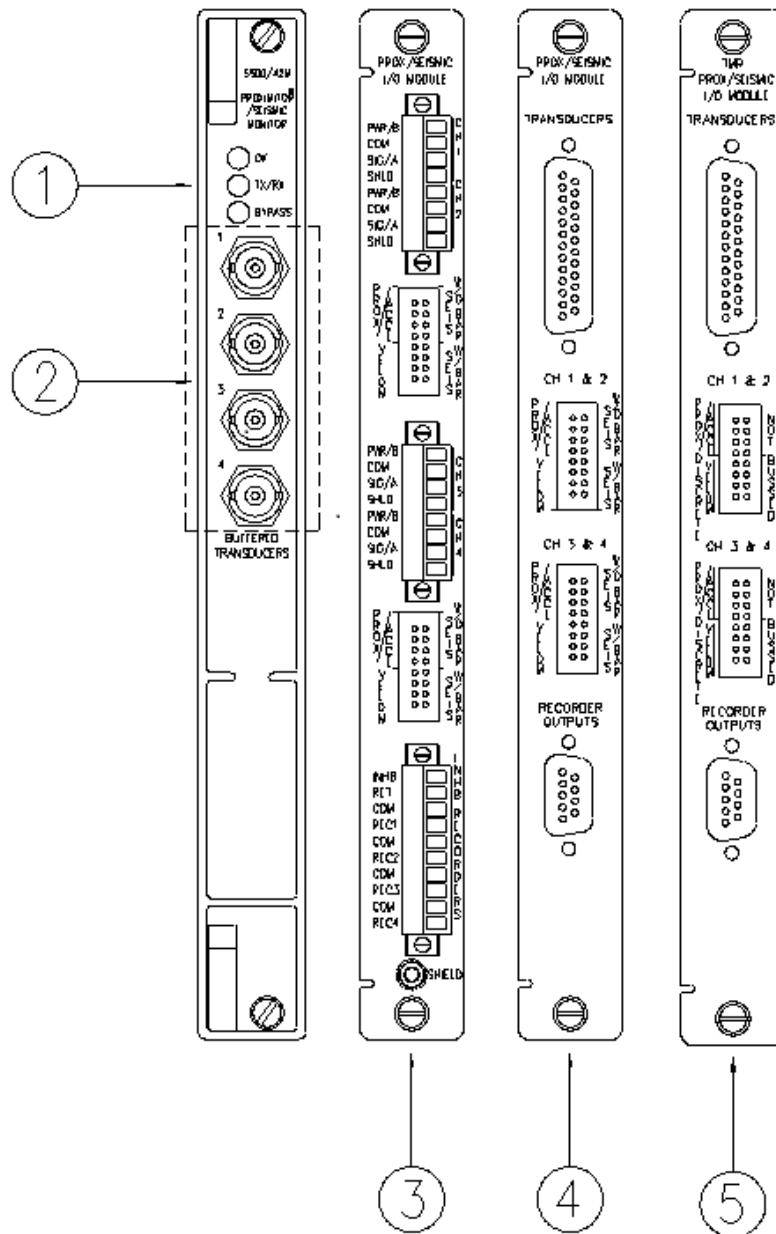

- 1: Status LEDs
- 2: Buffered Transducer Outputs
- 3: Prox/Seismic I/O Module with Internal Terminations
- 4: Prox/Seismic I/O Module with External Terminations
- 5: TMR I/O Module with External Terminations

Figure 1: Front and rear view of the Proximator / Seismic Monitor

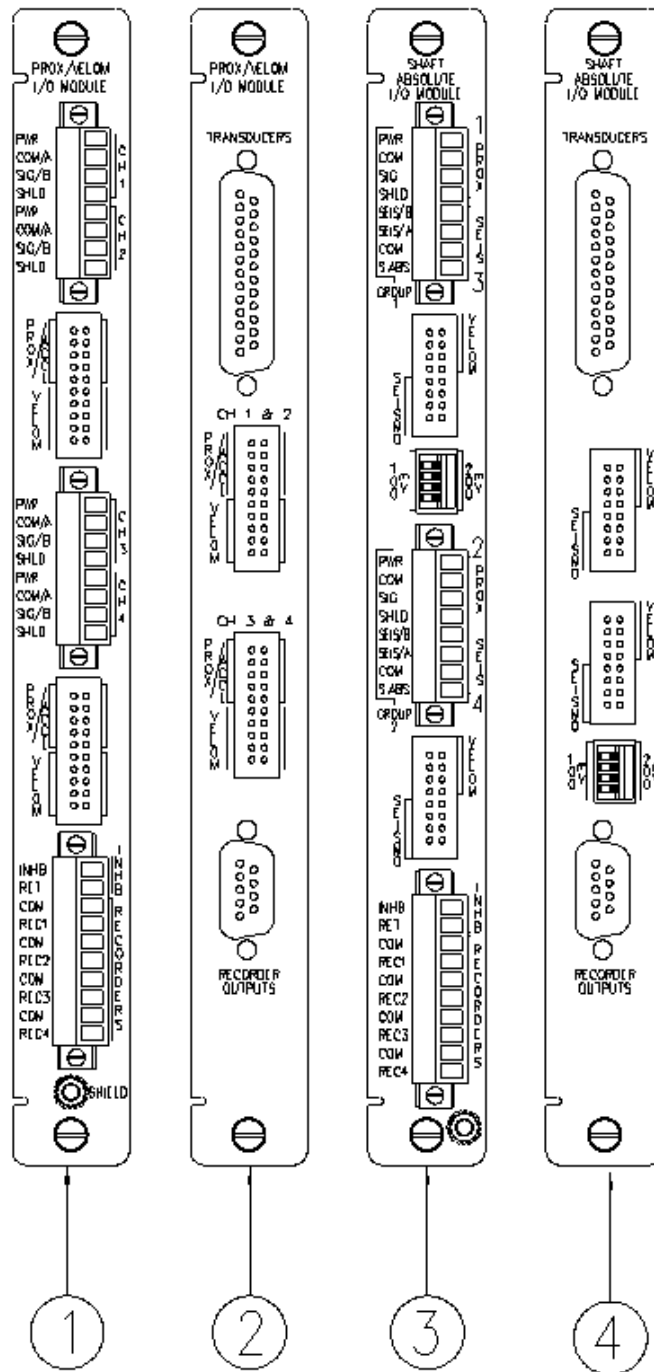

- 1: Prox/Velom I/O Module, Internal Terminations
- 2: Prox/Velom I/O Module, External Terminations
- 3: Shaft Absolute I/O Module, Internal Terminations
- 4: Shaft Absolute I/O Module, External Terminations

Figure 2: Additional I/O Modules of the Proximitor / Seismic Monitor

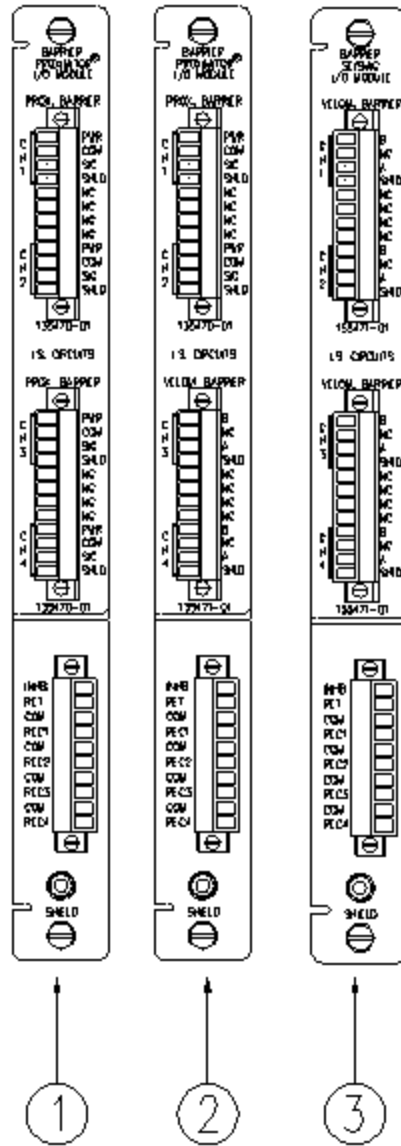

- 1: Barrier I/O Module for connecting four proximitors
- 2: Barrier I/O Module for connecting four proximitors and two velomitor sensor
- 3: Barrier I/O Module for connecting four velomitor sensors

Figure 3: Barrier I/O Modules of the Proximitors / Seismic Monitor

REBAM Channels

The following graphs show the maximum machine speed allowed for a monitor channel pair configured for REBAM. The maximum speed depends on the number of rolling elements in the bearing.

The graphs are generated with the following assumptions:

- The rotor lowpass filter corner is set at 3.2 times the shaft speed.
- The spike highpass filter corner is set at four times the element pass frequency for the outer race (BPFO).

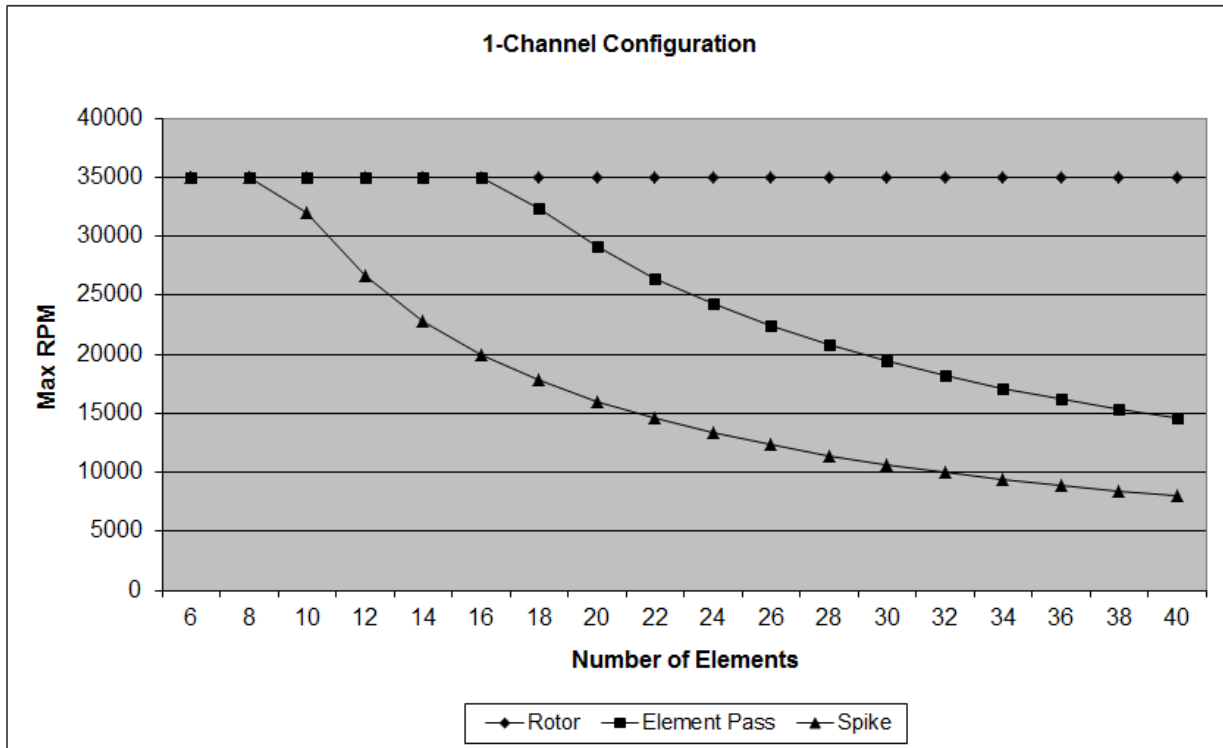

Figure 4: Both channels of the channel pair are enabled.

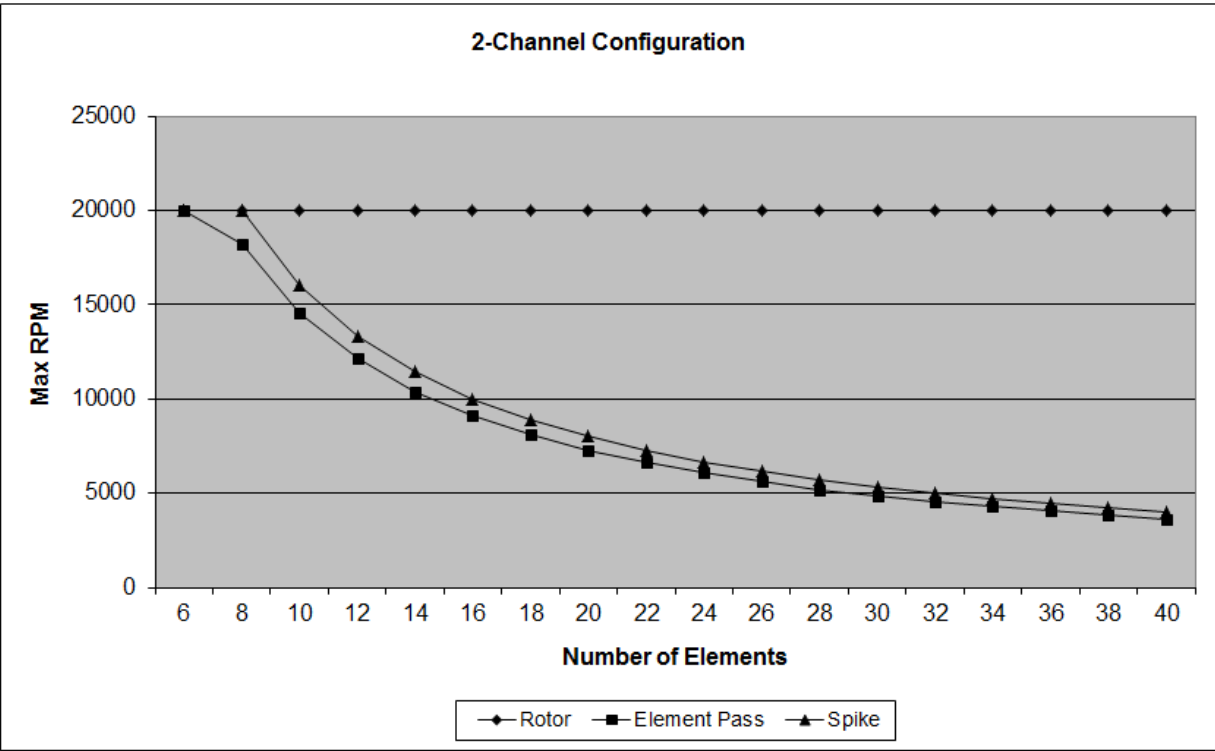

Figure 5: Only one channel of a channel pair is enabled.

© 1999 - 2016 Bently Nevada, Inc. All rights reserved.

* Denotes a trademark of Bently Nevada, Inc., a wholly owned subsidiary of General Electric Company. The information contained in this document is subject to change without prior notice.

Printed in USA. Uncontrolled when transmitted electronically.

1631 Bently Parkway South, Minden, Nevada USA 89423

Phone: 1-775.782.3611 Fax: 1-775.215.2873

www.GEmeasurement.com